



Caratteristiche tecniche:

- Scatola e bocchetta in acciaio verniciate grigio alluminio
- Scrocco autobloccante
- Entrata regolabile da 50 a 80 mm
- Cilindro esterno a tubo e lunghezza 55 mm
- Tensione 12 V ca
- Corrente assorbita 2,5A

Dotazione:

- Bocchetta
- Foglio Istruzioni
- Viti fissaggio
- 3 chiavi art. 1.01070.10.1

A richiesta:

- Modello Booster art. 1.07022.000

Normative:

- Questa serie di elettroserrature è certificata secondo la norma Europea EN 14846:08:

| 3 | C | 2 | 0 | 0 | M | 3 | 0 | 2 |

- grado 3 Security (500 Kg. alla spinta laterale e 200 Kg. alla spinta frontale)

Mano:

- 1 = destra interna
- 2 = sinistra interna
- 3 = destra esterna
- 4 = sinistra esterna

Tipologia	Descrizione	Cilindro	Mandate	Entrata	Unitario	Pezzi	ARTICOLO				
							Tipo	Dim.	Mano	Fin.	Pers.

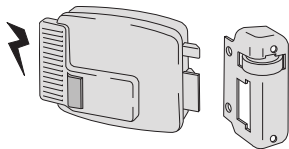

• Pulsante interno



Art. 1 0G500 00 0 12

50	1,150	1	1	11610 50 1 N7
50	1,150	1	1	11610 50 2 N7
60	1,150	1	1	11610 60 1 N7
60	1,150	1	1	11610 60 2 N7
70	1,150	1	1	11610 70 1 N7
70	1,150	1	1	11610 70 2 N7
80	1,150	1	1	11610 80 1 N7
80	1,150	1	1	11610 80 2 N7



Art. 1 0G200 55 0 12

50	1,440	1	1	11611 50 1 N7
50	1,440	1	1	11611 50 2 N7
60	1,440	1	1	11611 60 1 N7
60	1,440	1	1	11611 60 2 N7
70	1,440	1	1	11611 70 1 N7
70	1,440	1	1	11611 70 2 N7
80	1,440	1	1	11611 80 1 N7
80	1,440	1	1	11611 80 2 N7

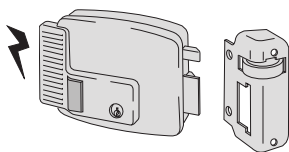

• Pulsante interno e cilindro
• Fermo a giorno



Art. 1 02104 00 0 12

50	1,530	1	1	11630 50 1 N7
50	1,530	1	1	11630 50 2 N7
60	1,530	1	1	11630 60 1 N7
60	1,530	1	1	11630 60 2 N7
70	1,530	1	1	11630 70 1 N7
70	1,530	1	1	11630 70 2 N7
80	1,530	1	1	11630 80 1 N7
80	1,530	1	1	11630 80 2 N7



Art. 1 02110 00 0 12

50	1,530	1	1	11631 50 1 N7
50	1,530	1	1	11631 50 2 N7
60	1,530	1	1	11631 60 1 N7
60	1,530	1	1	11631 60 2 N7
70	1,530	1	1	11631 70 1 N7
70	1,530	1	1	11631 70 2 N7

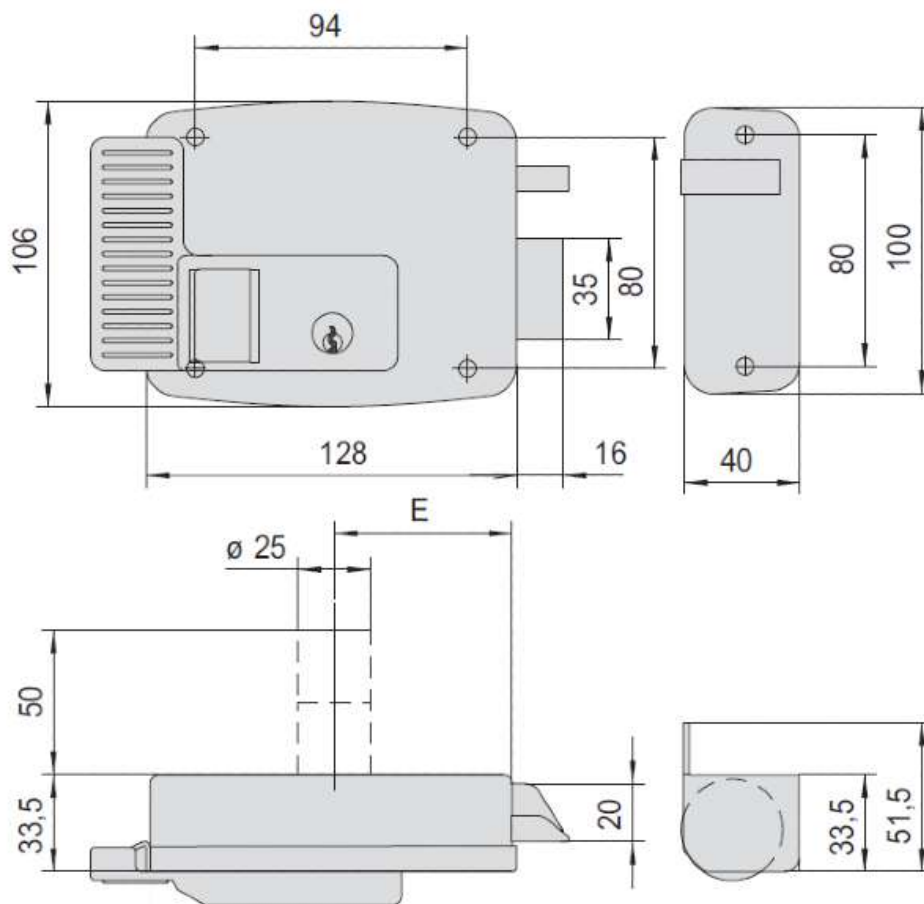

11611-11631

E = 50 - 60 - 70 - 80

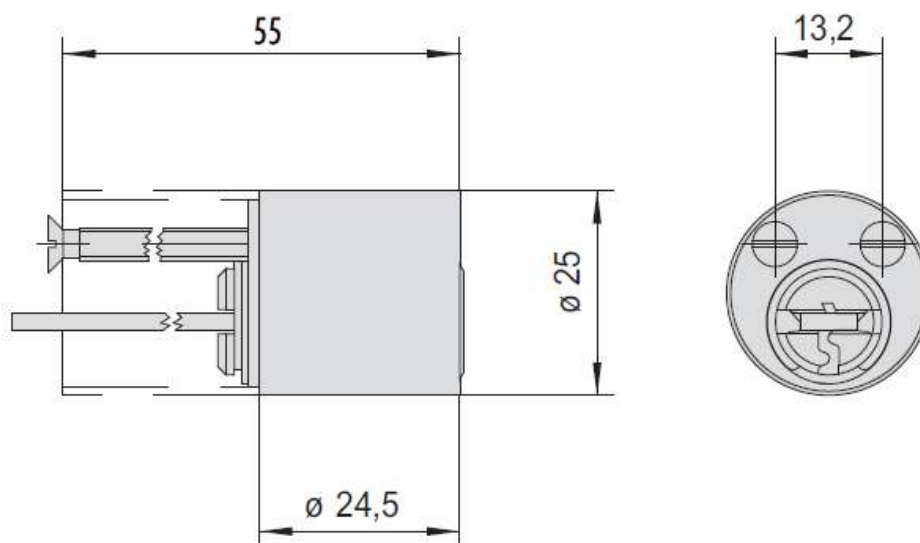

0A210, 0E200, 0G200, 0M210, 0N210
0P210, 0Q210, 0R210, 0X210