

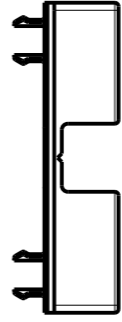

21.11.2017

Freigabe

© ISO 16016: WEITERGABE SOWIE VERVIELFÄLTIGUNG DIESER UNTERLAGEN, VERWERTUNG UND MITTEILUNG IHRES INHALTS IST NICHT GESTATTET, SOWEIT NICHT AUSDRUECKLICH ZUGESTANDEN. ZUM IERHANDLUNGEN VERPFLICHTEN ZU SCHADENERSATZ. ALLE RECHTE FUER DEN FALL DER PATENTIERUNG ODER GEBRAUCHSMUSTER-EINTRAGUNG VORBEHALTEN. THE REPRODUCTION, DISTRIBUTION AND UTILIZATION OF THIS DOCUMENT AS WELL AS THE COMMUNICATION OF ITS CONTENTS TO OTHERS WITHOUT EXPLICIT AUTHORIZATION IS PROHIBITED. OFFENDERS WILL BE HELD LIABLE FOR THE PAYMENT OF DAMAGES. ALL RIGHTS RESERVED IN THE EVENT OF THE GRANT OF A PATENT, UTILITY MODEL OR DESIGN.

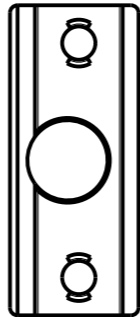
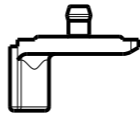
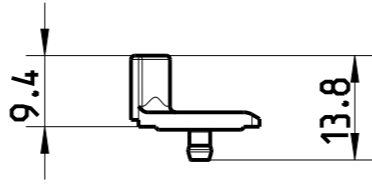
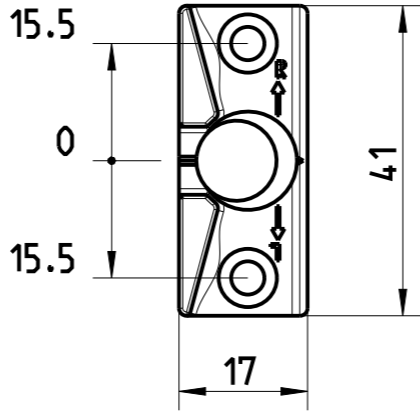
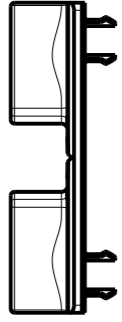

Geprueft/Check	Date:	09.11.2017	Name:	Braendle
Maßstab Scale 1:1	Rahmenteil NSP SFG NT (-)			
Roto Frank AG 	828120013200_D		Blatt/Sheet 1/1	Model Name 82812K013210
			Index 01	