

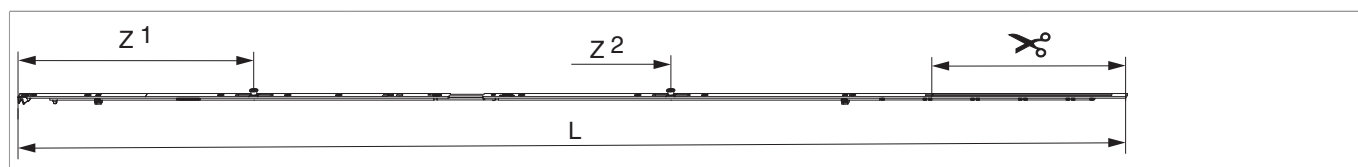

210337 - Componente altezza MM RS-CN/AA 1590 con 2 funghi HBB 1.341-1.590 argento

Disegni tecnici



				L			Nº
argento	con 2 funghi	1590	260	1.486,5	1.341 - 1.590	10	210337

Tabella posizionamento viti

Nº		1	2	3	4	5	6	7	8	9	10	11	12	13	14
210337	9	18,5	91,5	270	360	428,5	674	830	920	1.119					

Tabella punti di chiusura

Nº		Z1	Z2	Z3	Z4
210337	2	315	875		

Montaggio

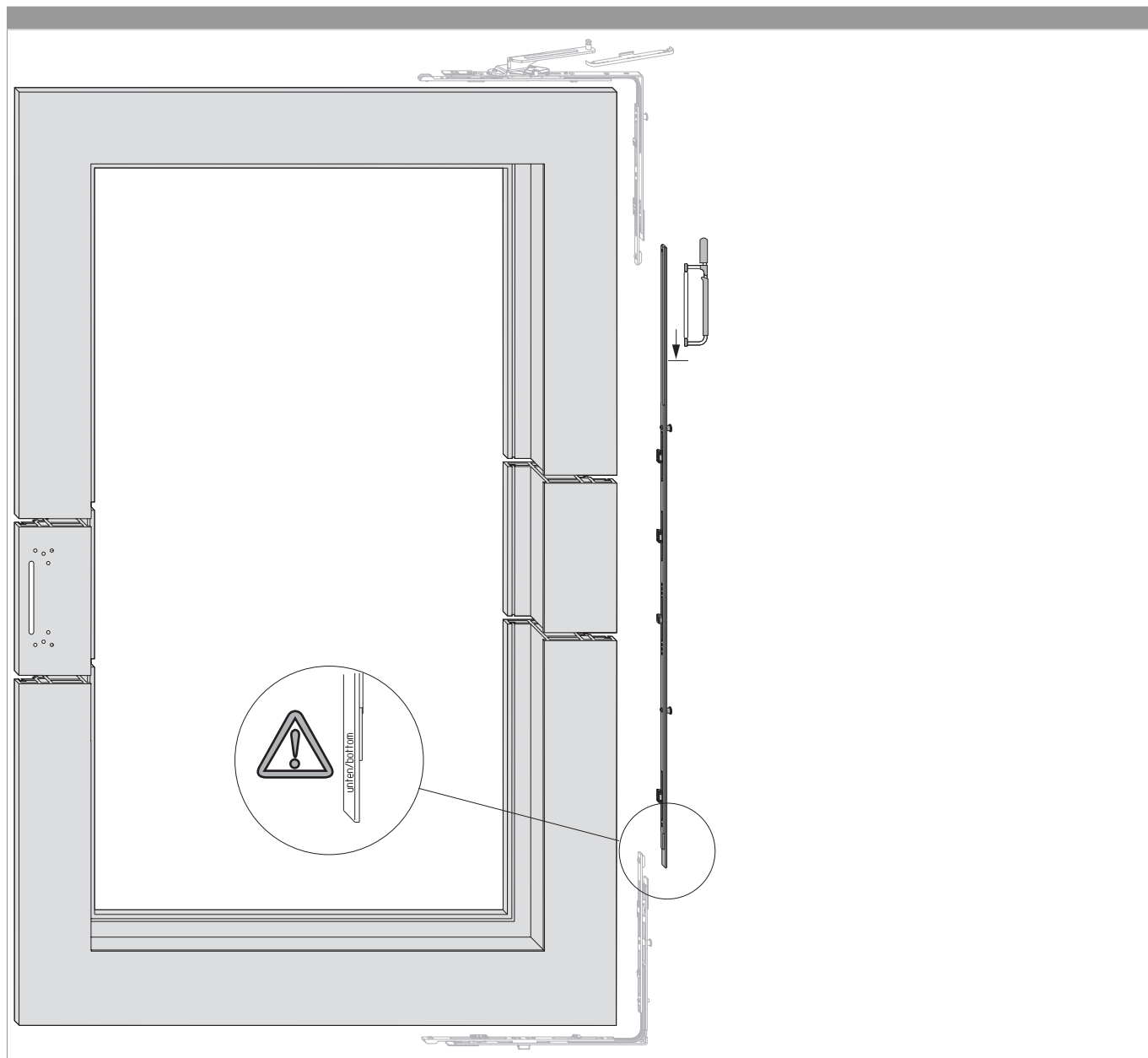

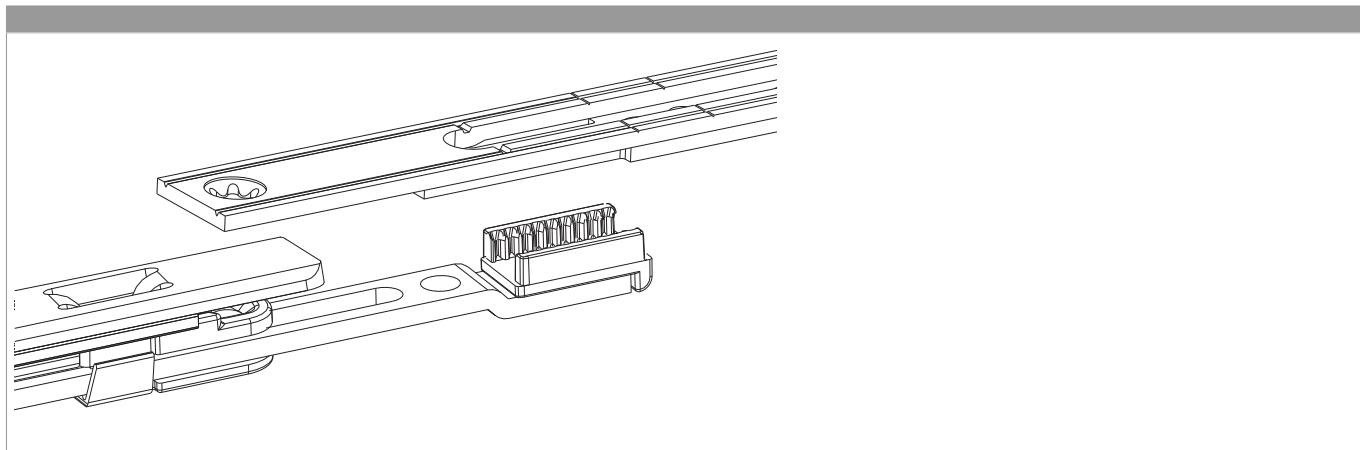

Regolazione pressione

Fungo e nottolino

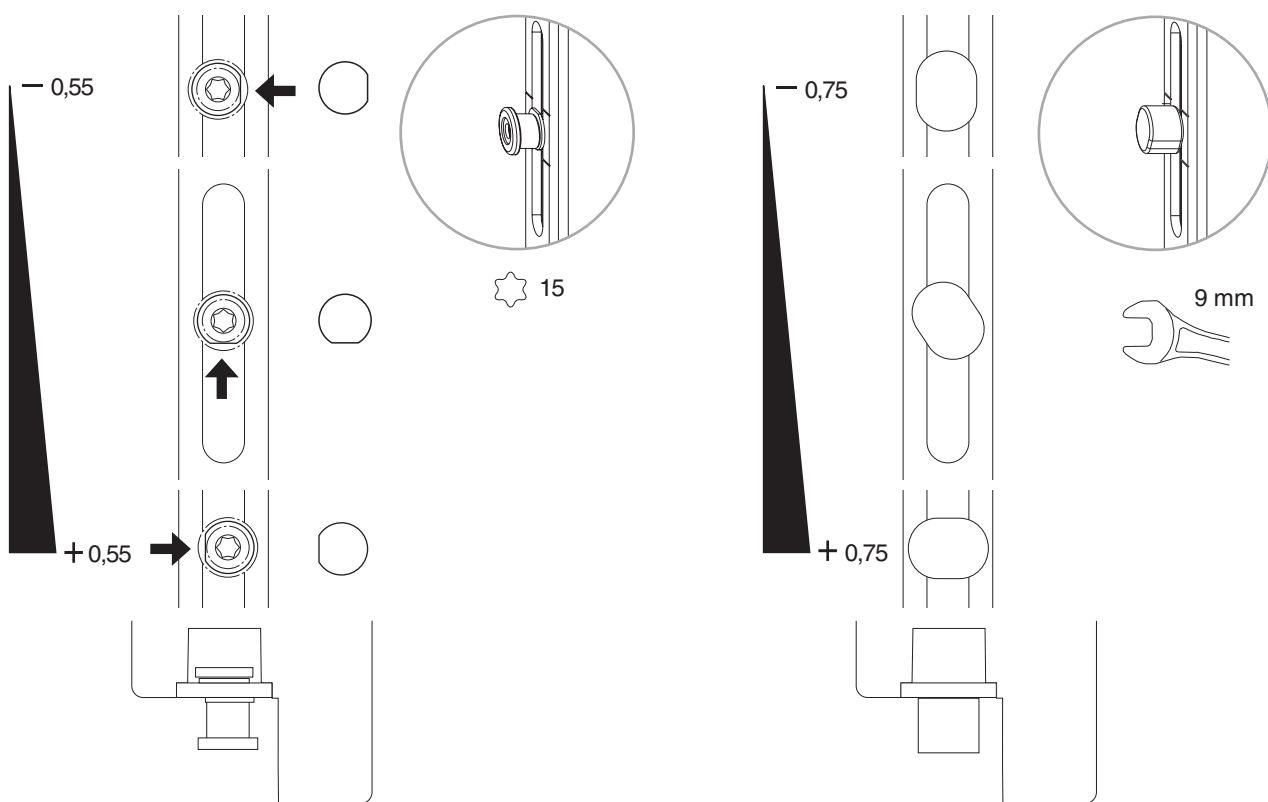
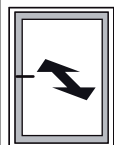

• solo per grandezza 1050 e 1300