

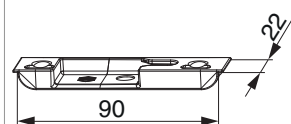

357673 - Scontro fungo per A4 scost. 13 mm con vite inclinata destro argento

Disegni tecnici



					L	B	H		Nº
argento	per A4 scost. 13 mm	con vite inclinata		destro	90	22	8	100	357673 ^{1) 2)}



¹⁾ Lunghezza fresata 90 mm

²⁾ Profondità fresata 22 mm

Dime

							Nº
Dima fresa per cremonese fix MM con bilanciére			Aria 4		661 - 1.090	1	214152
Dima fresa per cremonese fix MM con bilanciére			Aria 4		841 - 1.340	1	214153
Dima fresa per cremonese fix MM con bilanciére			Aria 4		1.341 - 1.700	1	214154
Dima fresa per cremonese fix MM con bilanciére			Aria 4		1.701 - 2.200	1	214155
Dima fresa per cremonese fix MM con bilanciére	scrocco porta		Aria 4		1.701 - 2.200	1	214156
Dima fresa per chiusura centrale inferiore MM			Aria 4	801 - 1.500		1	214677
Dima fresa per chiusura centrale inferiore MM-bilanciére			Aria 4	801 - 1.500		1	214163
Dima fresa per chiusura centrale lato cerniere MM-bilanciére			Aria 4		801 - 2.450	1	214162
Dima fresa per chiusura centrale lato cerniere MM con bilanciére			Aria 4		801 - 1.500	1	214161
Dima fresa per cremonese fix MM con bilanciére		2 ante	Aria 4		841 - 1.340	1	214157

Dime

							N°
Dima fresa per cremonese fix MM con bilanciare		2 ante	Aria 4		1.341 - 1.700	1	214158
Dima fresa per cremonese fix MM con bilanciare		2 ante	Aria 4		1.701 - 2.200	1	214159
Dima fresa per cremonese fix MM con bilanciare	scrocco porta	2 ante	Aria 4		1.701 - 2.200	1	214160
Dima fresa per chiusura centrale inferiore MM-bilanciare		2 ante	Aria 4	801 - 1.500		1	214164

Sezioni profilo

A4 scost.13 - 1 anta

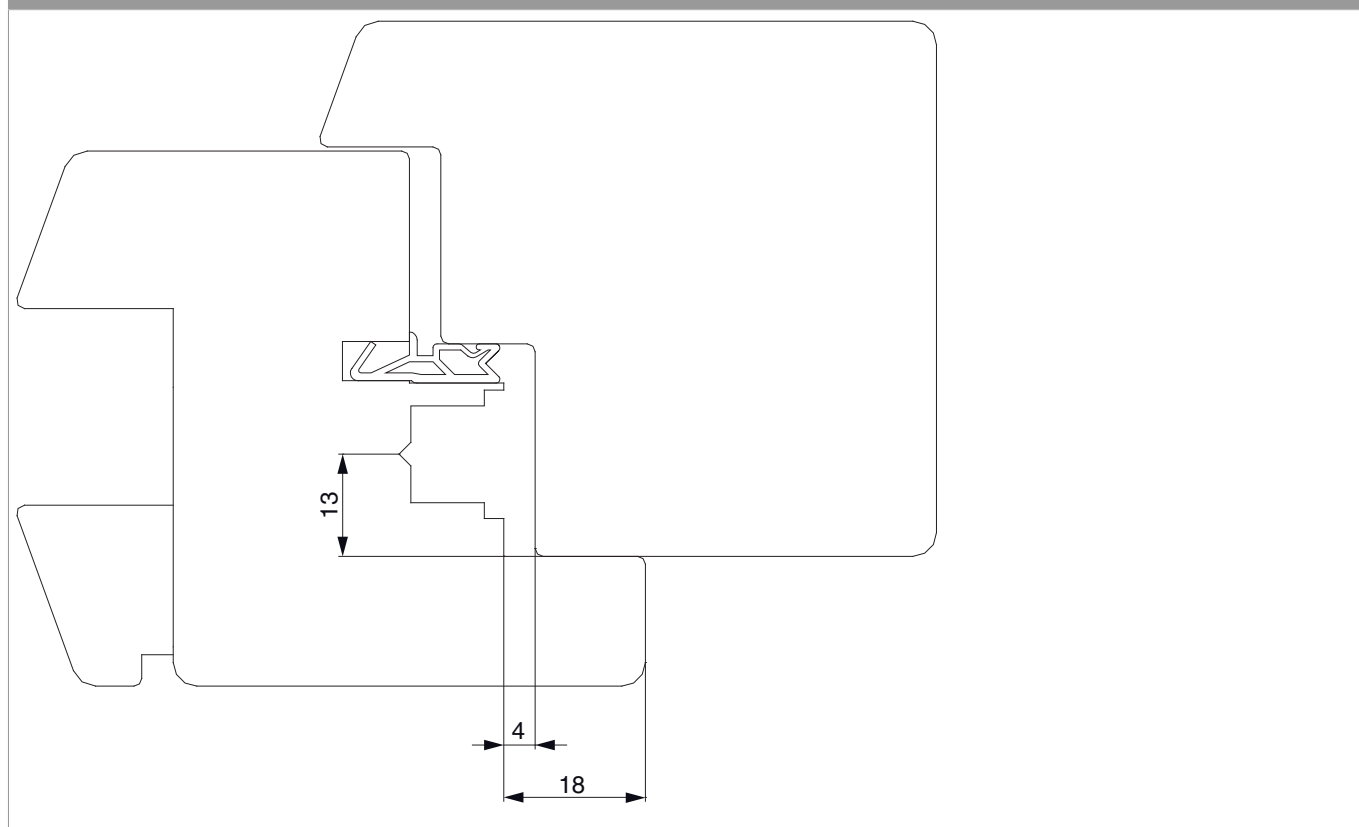

A4 scost.13 - 2 ante

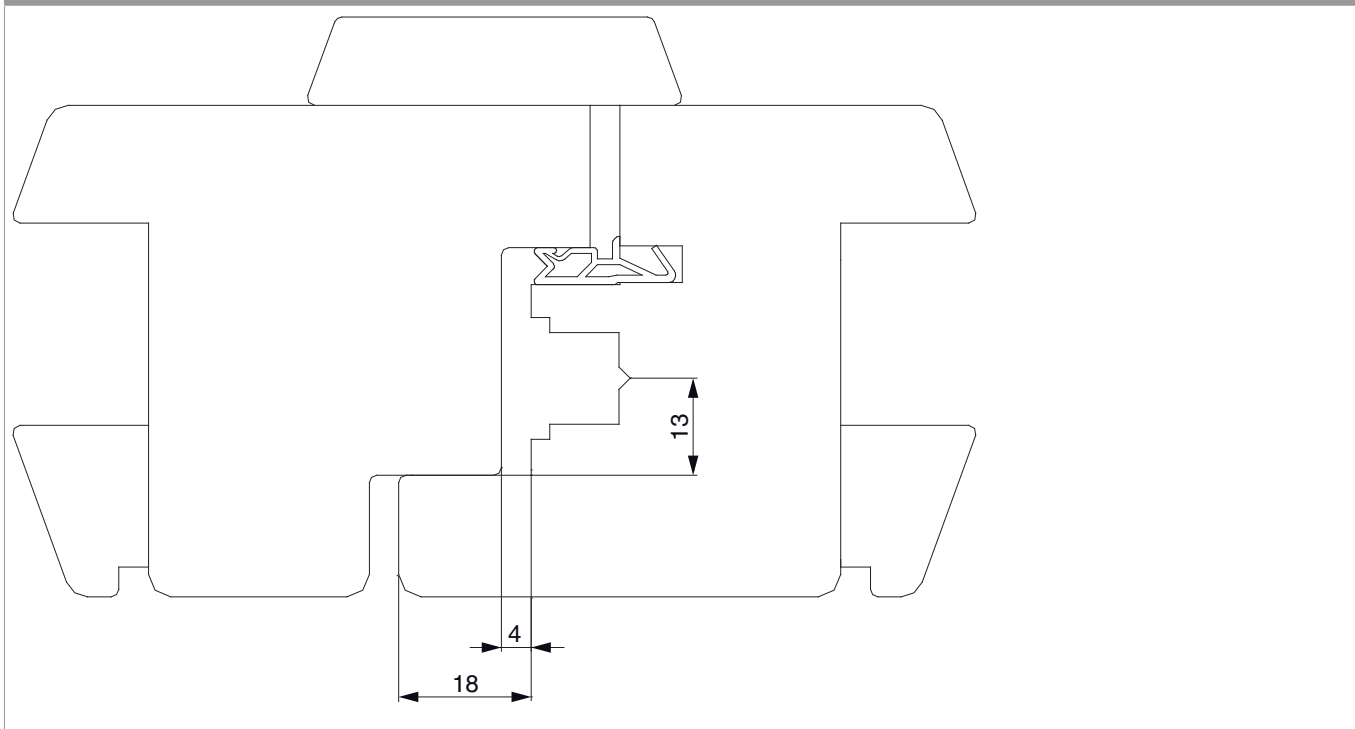

Posizionamento degli scontri

Scontri fungo A4

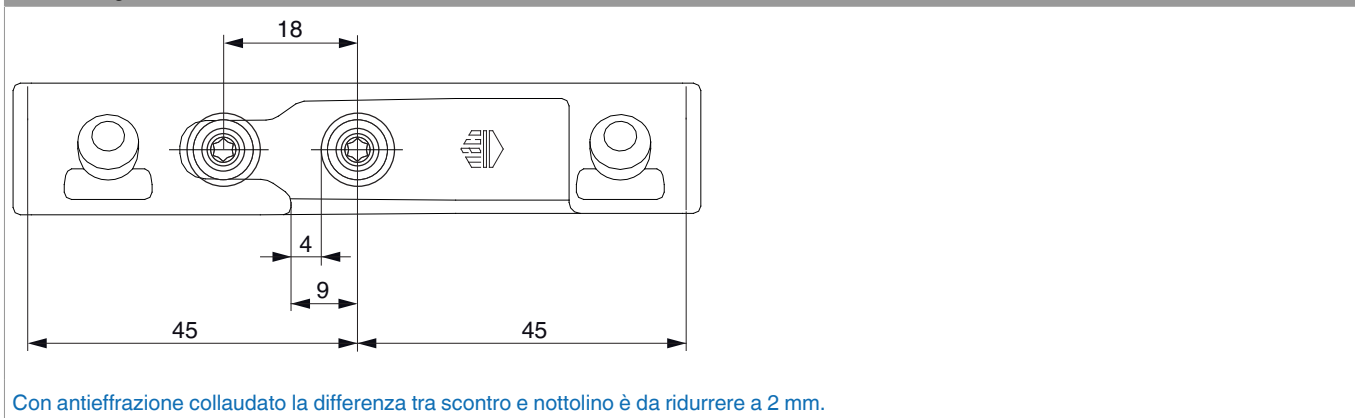

Fresata

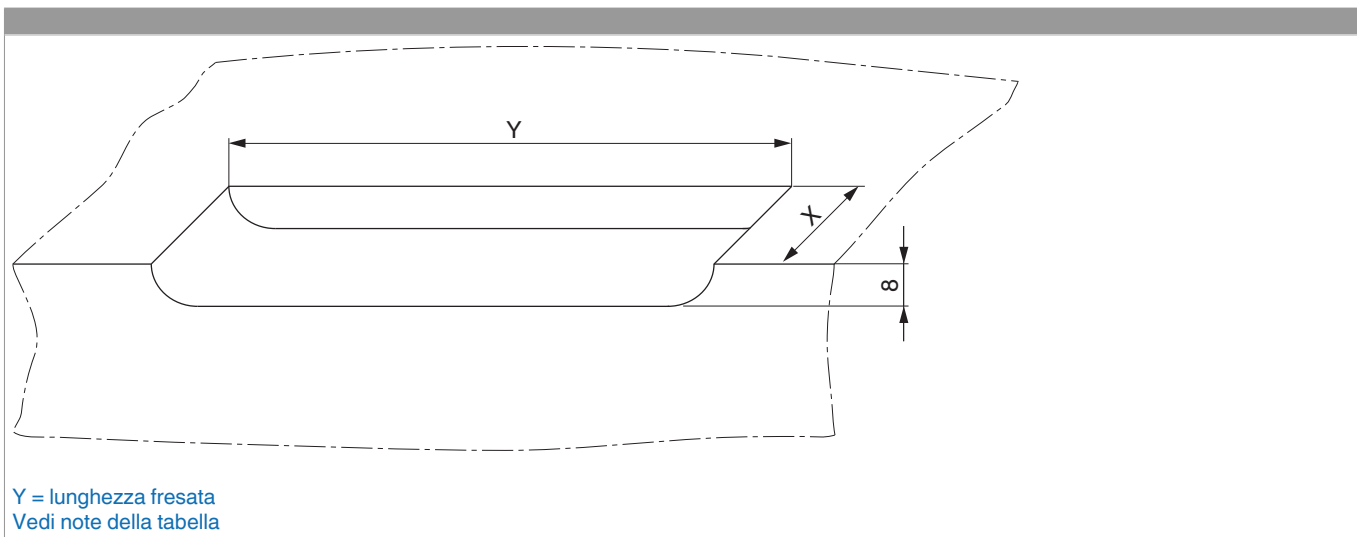

Scosta- mento	X
scosta- mento 9 mm	18 mm
scost.13	22 mm