

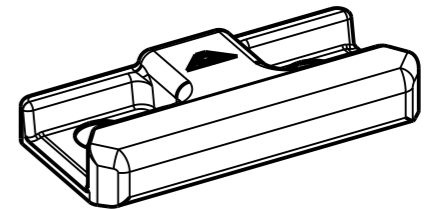

© ISO 16016: WEITERGABE SOWIE VERVIELFÄLTIGUNG DIESER UNTERLAGEN, VERWERTUNG UND MITTEILUNG IHRES INHALTS IST NICHT GESTATTET. SOWEIT NICHT AUSDRUECKLICH ZUGESTANDEN. ZUM IDERHANDLUNGEN VERPFLICHTEN ZU SCHADENERSATZ. ALLE RECHTE FUER DEN FALL DER PATENTIERUNG ODER GEBRAUCHSMUSTER-EINTRAGUNG VORBEHALTEN. THE REPRODUCTION, DISTRIBUTION AND UTILIZATION OF THIS DOCUMENT AS WELL AS THE COMMUNICATION OF ITS CONTENTS TO OTHERS WITHOUT EXPLICIT AUTHORIZATION IS PROHIBITED. OFFENDERS WILL BE HELD LIABLE FOR THE PAYMENT OF DAMAGES. ALL RIGHTS RESERVED IN THE EVENT OF THE GRANT OF A PATENT, UTILITY MODEL OR DESIGN.

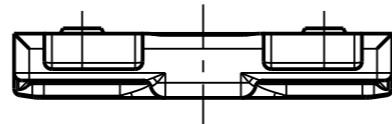
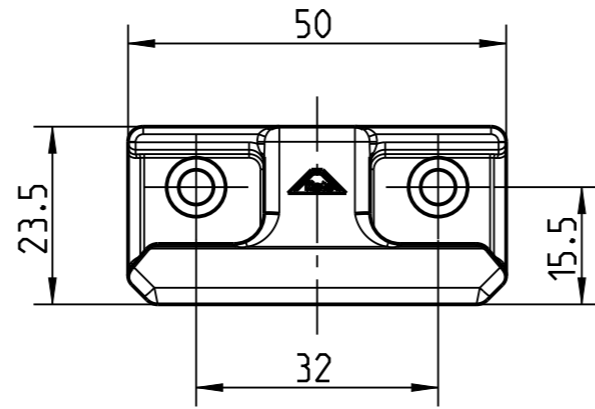
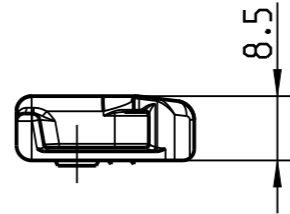
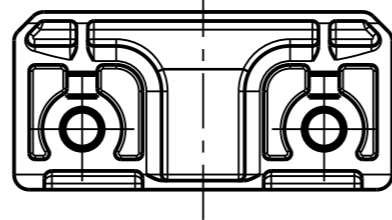
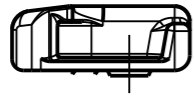

Geprueft/Check	Date:	17.08.2018	Name:	Schneider_E
Maßstab Scale 1:1	Schl.st.K Holz 13. FT 24; Stabil: NT (striker)			
Roto Frank AG 		525099_D		
Blatt/Sheet 1/1	Model Name 525099	Index 01		