

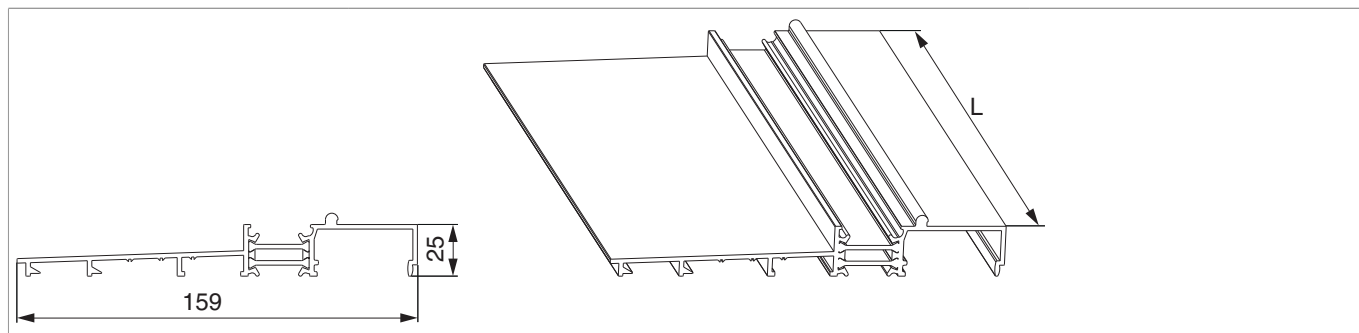



N22115 - Soglia HS a taglio termico S=159 mm H=25 mm L=5.000mm argento

Disegni tecnici



			L		No
Soglia HS a taglio termico	argento	S=159 mm H=25 mm	5.000	1	N22115