

cd511

Design: Colombo Design

MISURA FRESATA 28 x 113 x 8mm
MILING SIZE 28 x 113 x 8mm

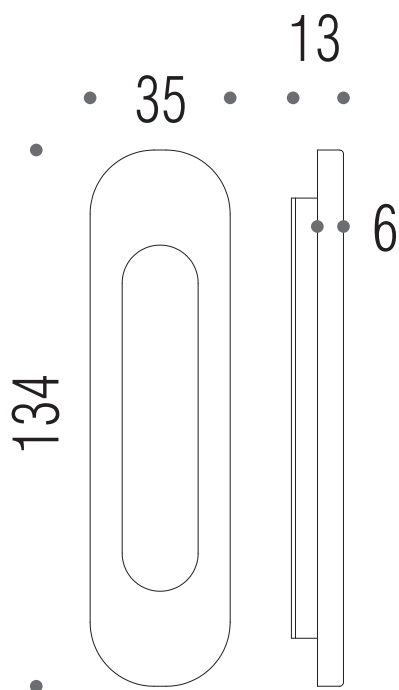

MFx
misura larghezza fresata
milling width

MFy
misura altezza fresata
milling height

MP
misura profondità fresata
milling depth

