



357672 - Scontro nottolino per A4 scost. 13 mm sinistro pressione - 1 mm argento

Disegni tecnici



				L	B	H		Nº
argento	per A4 scost. 13 mm	pressione - 1 mm	sinistro	90	22	8	200	357672 ^{1) 2)}

¹⁾ Lunghezza fresata 90 mm

²⁾ Profondità fresata 22 mm.



Dime

							Nº
Dima fresa per cremonese fix MM con bilanciare			Aria 4		661 - 1.090	1	214152
Dima fresa per cremonese fix MM con bilanciare			Aria 4		841 - 1.340	1	214153
Dima fresa per cremonese fix MM con bilanciare			Aria 4		1.341 - 1.700	1	214154
Dima fresa per cremonese fix MM con bilanciare			Aria 4		1.701 - 2.200	1	214155
Dima fresa per cremonese fix MM con bilanciare	scrocco porta		Aria 4		1.701 - 2.200	1	214156
Dima fresa per chiusura centrale inferiore MM			Aria 4	801 - 1.500		1	214677
Dima fresa per chiusura centrale inferiore MM-bilanciere			Aria 4	801 - 1.500		1	214163
Dima fresa per chiusura centrale lato cerniere MM-bilanciere			Aria 4		801 - 2.450	1	214162



357672 - Scontro nottolino per A4 scost. 13 mm sinistro pressione - 1 mm argento

Dime

								N°
Dima fresa per chiusura centrale lato cerniere MM con bilanci				Aria 4		801 - 1.500	1	214161
Dima fresa per cremonese fix MM con bilanci			2 ante	Aria 4		841 - 1.340	1	214157
Dima fresa per cremonese fix MM con bilanci			2 ante	Aria 4		1.341 - 1.700	1	214158
Dima fresa per cremonese fix MM con bilanci			2 ante	Aria 4		1.701 - 2.200	1	214159
Dima fresa per cremonese fix MM con bilanci		scrocco porta	2 ante	Aria 4		1.701 - 2.200	1	214160
Dima fresa per arco Multi Matic e Trend	legno		scatola forbice supplementare e scontri	Aria 4			1	41537



357672 - Scontro nottolino per A4 scost. 13 mm sinistro
pressione - 1 mm argento

Sezioni profilo

A4 scost.13 - 1 anta

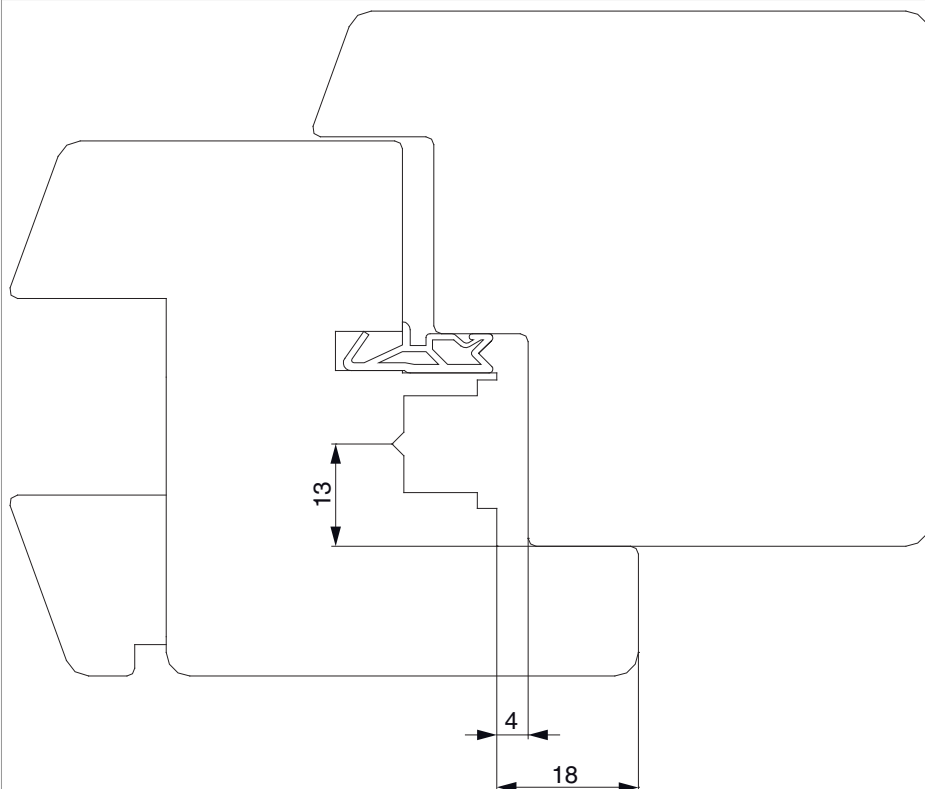

A4 scost.13 - 2 ante

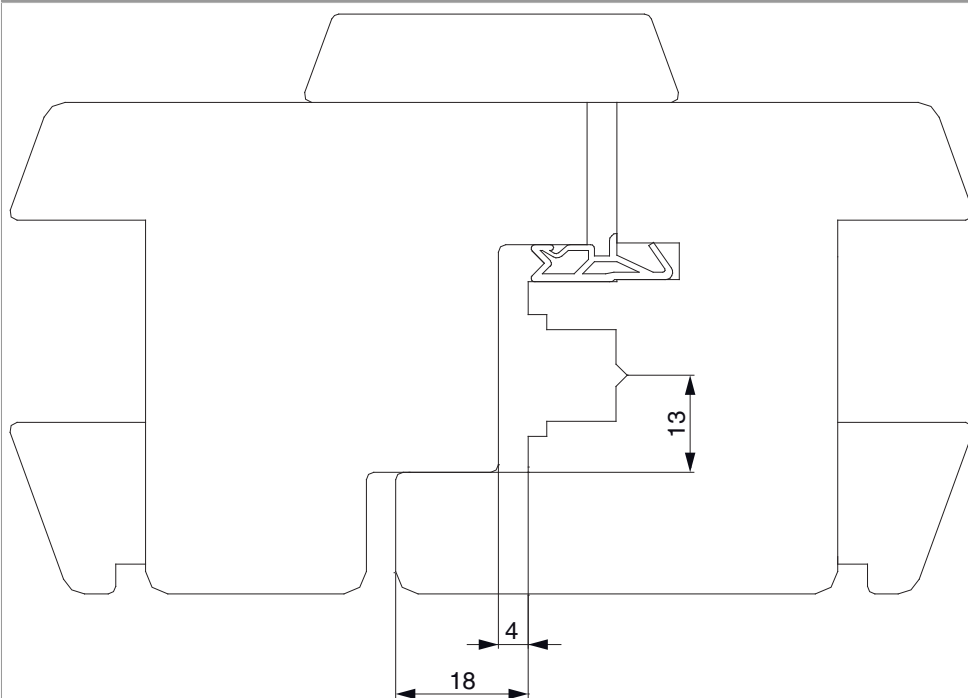



357672 - Scontro nottolino per A4 scost. 13 mm sinistro pressione - 1 mm argento

Posizionamento degli scontri

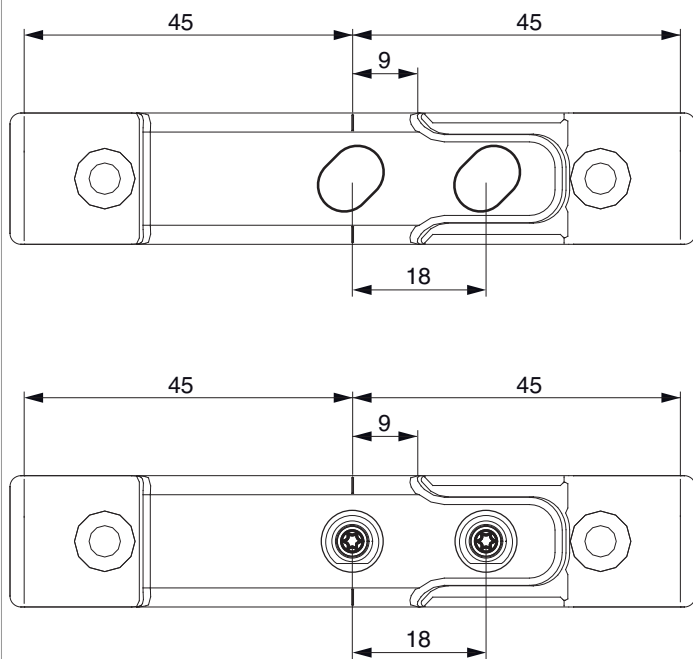

Quando si mette i scontri, si deve stare attento che il centro del nottolino e il centro dello scontro sono in linea!

Fresata

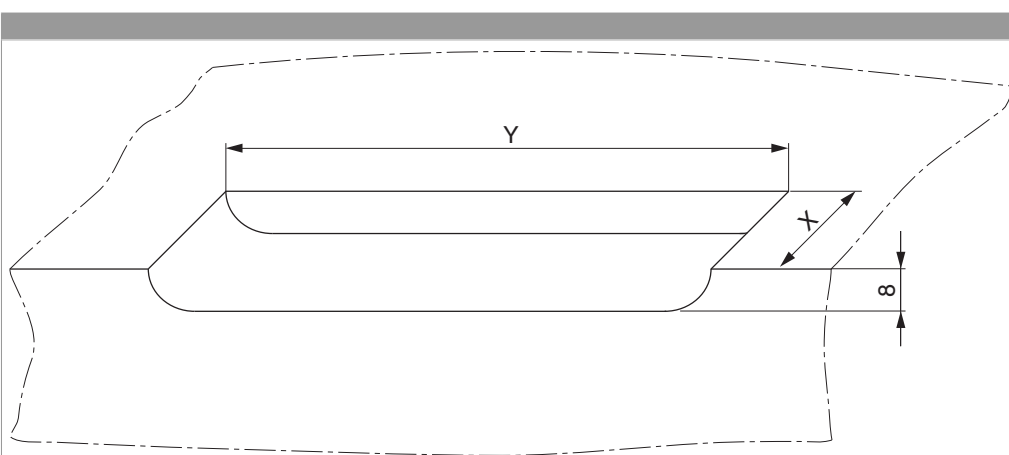

Y = lunghezza fresata
Vedi note della tabella.



**357672 - Scontro nottolino per A4 scost. 13 mm sinistro
pressione - 1 mm argento**

Scosta- mento	X
scosta- mento 9 mm	18 mm
scost.13	22 mm