

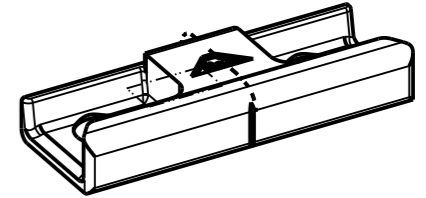

© ISO 16016: WEITERGABE SOWIE VERVIELFÄLTIGUNG DIESER UNTERLAGEN, VERWERTUNG UND MITTEILUNG IHRES INHALTS IST NICHT GESTATTET. SOWEIT NICHT AUSDRUECKLICH ZUGESTANDEN. ZUM IHRERHANDLUNGEN VERPFLICHTEN ZU SCHADENERSATZ. ALLE RECHTE FUER DEN FALL DER PATENTIERUNG ODER GEBRAUCHSMUSTER-EINTRAGUNG VORBEHALTEN. THE REPRODUCTION, DISTRIBUTION AND UTILIZATION OF THIS DOCUMENT AS WELL AS THE COMMUNICATION OF ITS CONTENTS TO OTHERS WITHOUT EXPLICIT AUTHORIZATION IS PROHIBITED. OFFENDERS WILL BE HELD LIABLE FOR THE PAYMENT OF DAMAGES. ALL RIGHTS RESERVED IN THE EVENT OF THE GRANT OF A PATENT, UTILITY MODEL OR DESIGN.

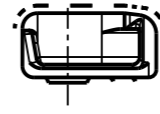
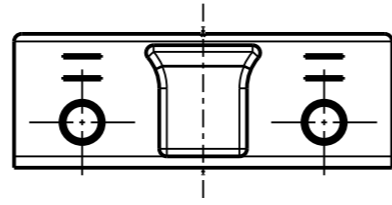
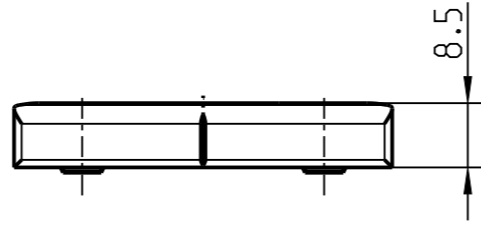
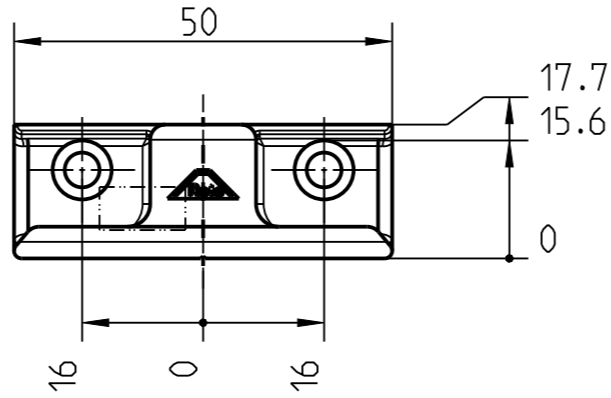
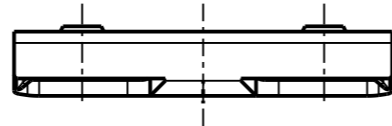
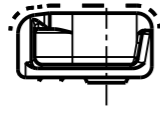

Geprueft/Check	Date:	18.08.2023	Name:	Horvath_R
Maßstab Scale 1:1	Schlst.H Eurofalz 18: NT (striker)			
 Roto	Roto Frank FTT GmbH	848230048000_D		Index 01
	Blatt/Sheet 1/1	Model Name 84823T048020		