

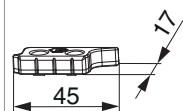



356299 - Scontro alza anta MultiMatic battuta liscia/18 con vite inclinata sinistro argento

Disegni tecnici



			L	B	H		Nº
argento	con vite inclinata	sinistro	45	17	8	100	356299

Dime

					Nº
Dima completa con guidascontro per cremonese fix MM	con guidascontro L= 48mm		431 - 660	1	204773
Dima completa con guidascontro per cremonese fix MM	con guidascontro L= 48mm		661 - 1.340	1	204774
Dima completa con guidascontro per cremonese fix MM	con guidascontro L= 48mm		1.341 - 1.700	1	204775
Dima completa con guidascontro per cremonese fix MM	con guidascontro L= 48mm	per porte	1.701 - 2.450	1	204776
Dima completa con guidascontro cremonese MM	con guidascontro L= 48mm	variabile (centrale)	1.250 - 1.750	1	206049
Dima completa con guidascontro cremonese MM	con guidascontro L= 48mm	variabile (centrale)	1.751 - 2.250	1	206067

Sezioni profilo

A12 battuta liscia PB18 - 1 anta

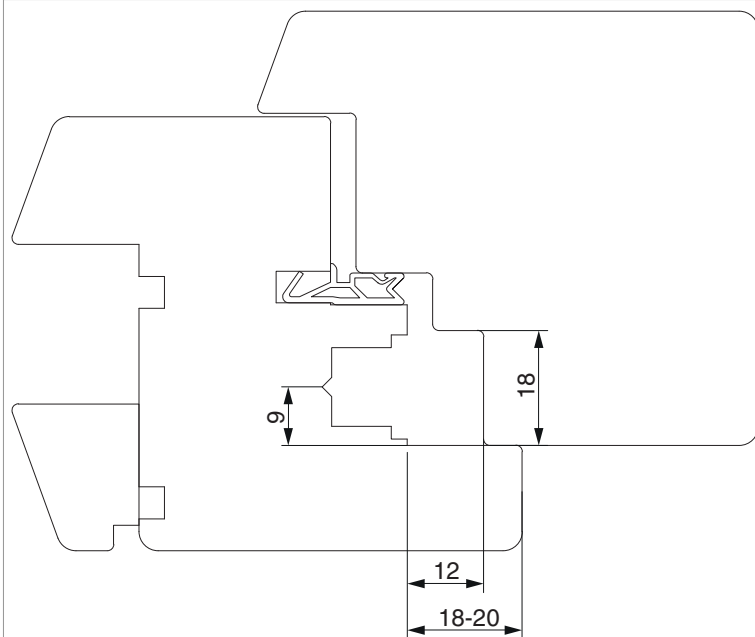

A12 battuta liscia PB18 - 2 ante

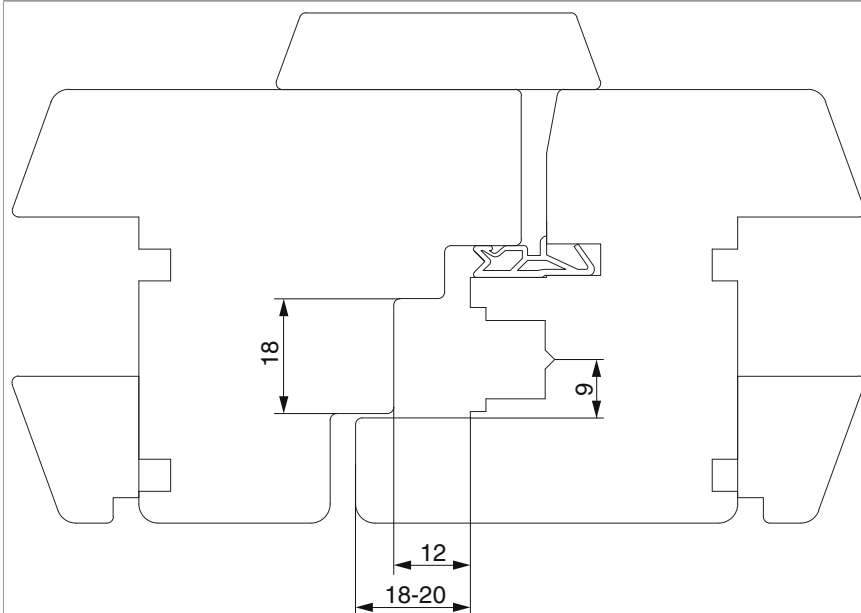

A12 battuta liscia PB20 scost.11 - 1 anta

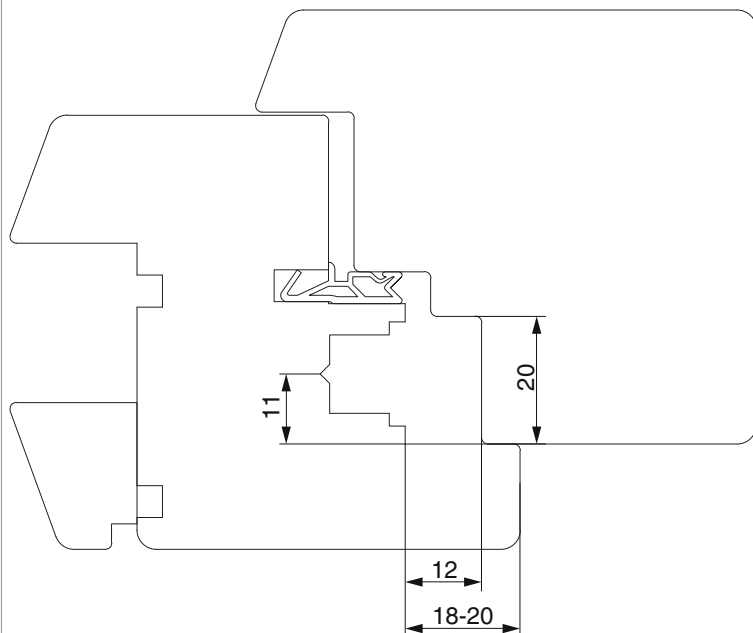

A12 battuta liscia PB20 scost.11 - 2 ante

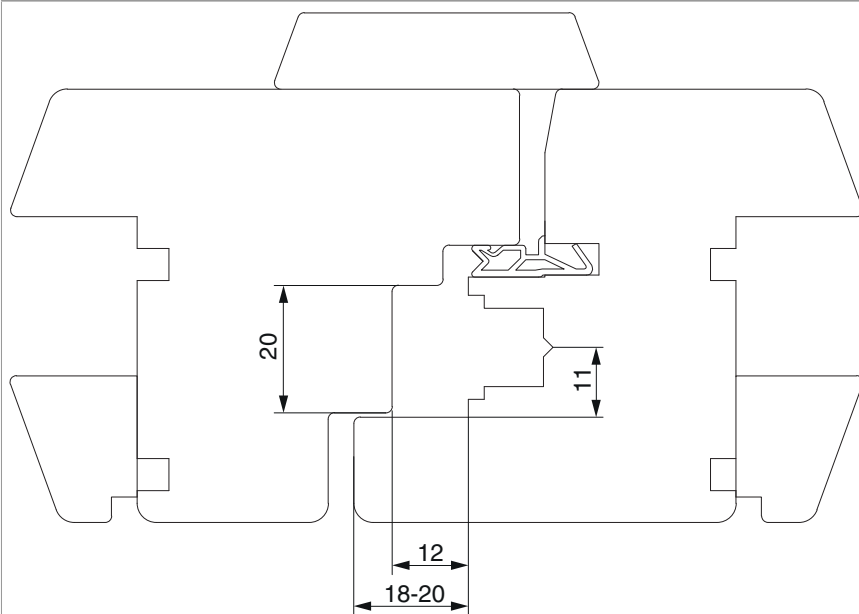



Posizionamento scontri alza anta

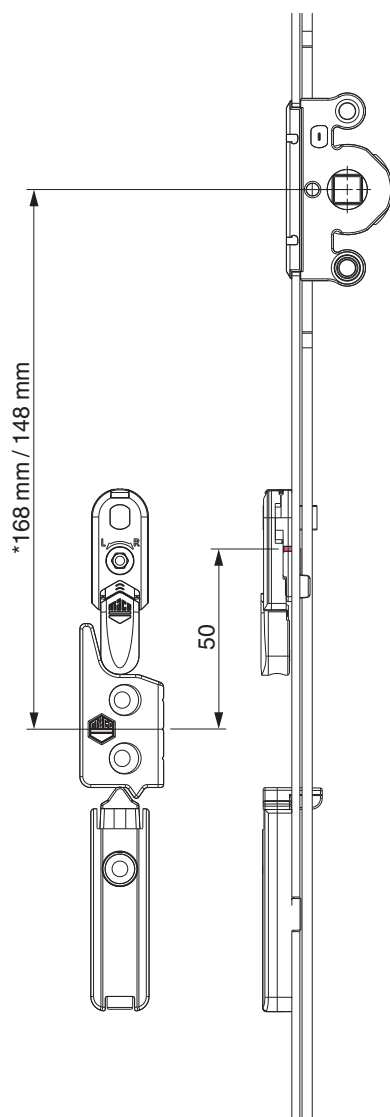

* con cremonesi grandezza 660