

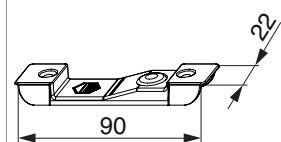

209364 - Scontro cuneo sollevamento arco per A4 scost. 13 mm argento

Disegni tecnici



				L	B	H		Nº
argento	Scontro cuneo sollevamento arco per A4 scost. 13 mm			90	22	8	50	209364 ^{1) 2) 3)}

¹⁾ Lunghezza fresata 90 mm

²⁾ Utilizzo con movimento angolare 215216, 215217.

³⁾ Profondità fresata 22 mm

Dime

			Nº
Dima fresa Multi Matic e Trend per arco scatola forbice supplementare e scontri Aria 4 legno		1	41537

Schema di fresata

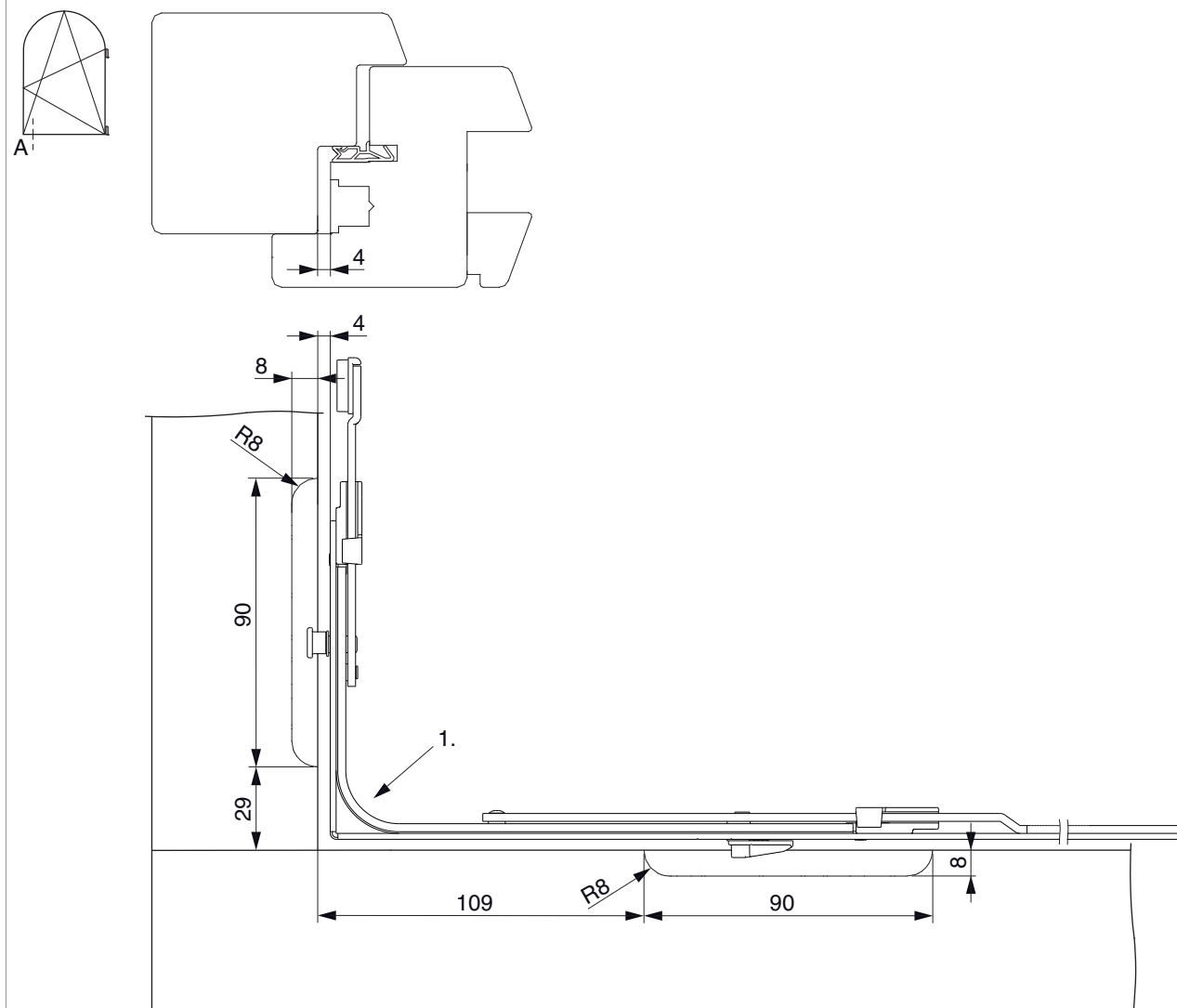

Profondità di fresata vedi nota su tabella articoli
1. Movimento angolare 215217

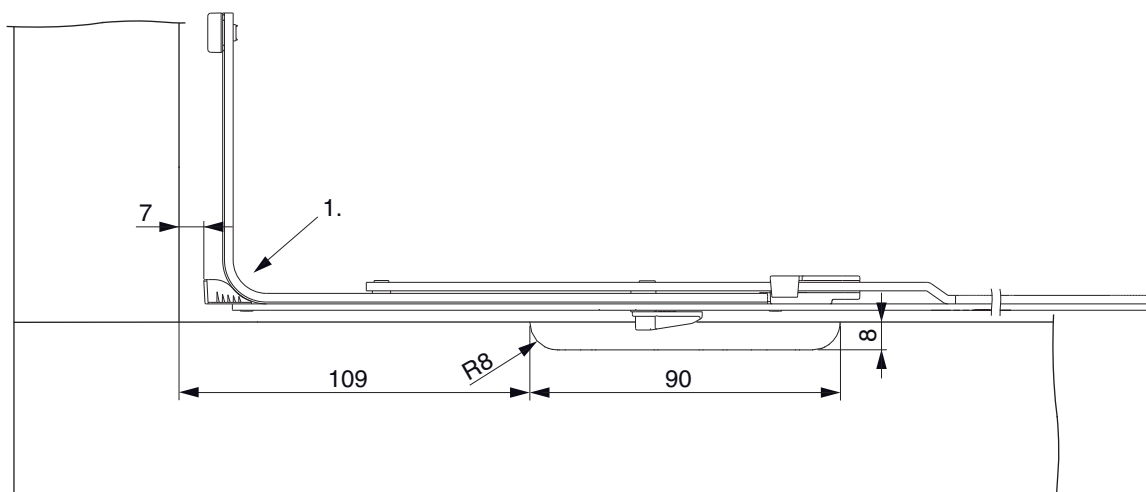
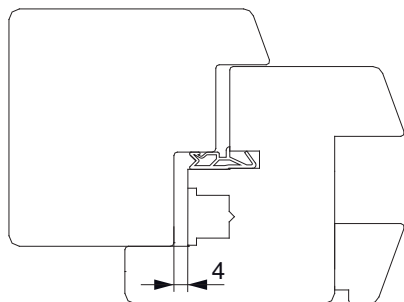
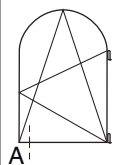

Profondità di fresata vedi nota su tabella articoli
1. Movimento angolare 215216

Fresata

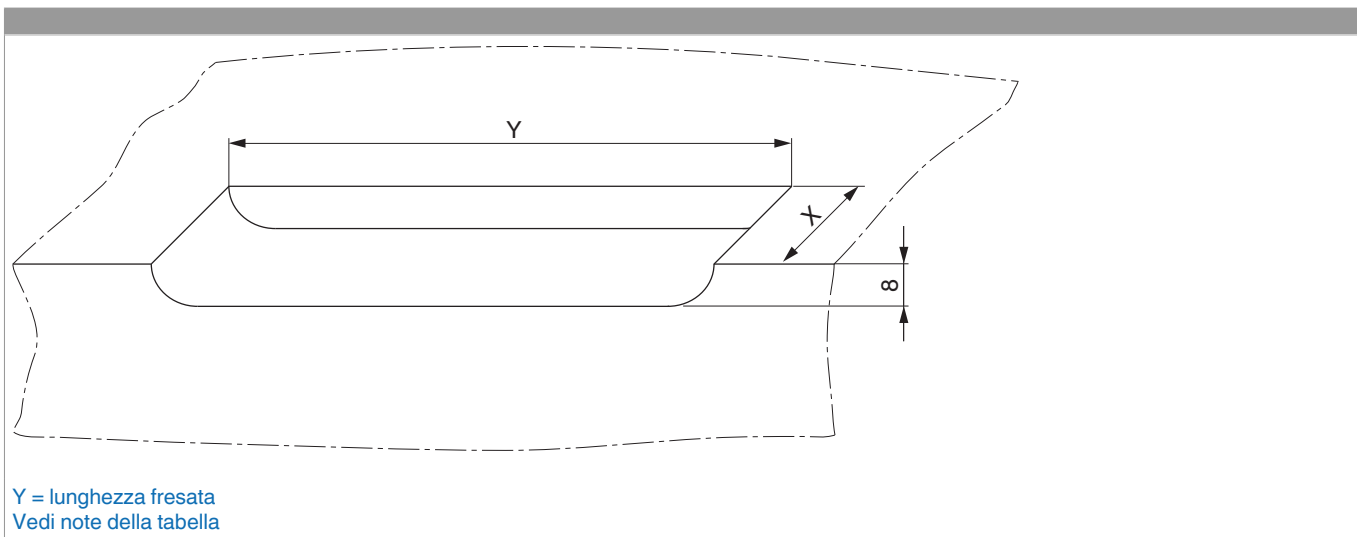

Scosta-mento	X
scosta-mento 9 mm	18 mm
scost.13	22 mm

Regolazione altezza

